

# Adjustable Levelling Feet

Levelling Feet are simple, low cost products suitable for most types of machinery. They allow machinery to be levelled and also provide a degree of vibration and noise reduction. The KA and MFL mountings have an integral levelling feature.

## Applications:

- Machine tools
- Lathes; Presses
- Heavy industrial equipment
- Conveyors
- Food processing

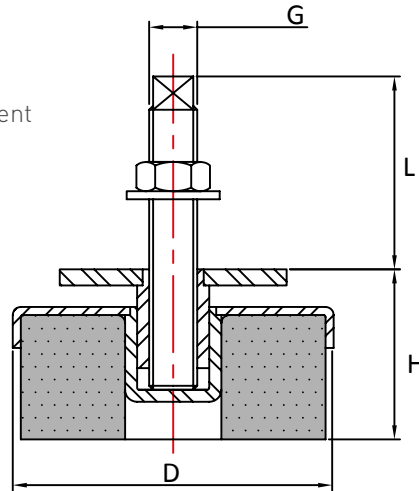

Part No	D	H	G	L	Max Load (kg)
MFL-1	80	38-48	M12	65-75	500
MFL-2	120	43-55	M16	68-80	1000
MFL-3	160	48-53	M20	110-125	2000
MFL-4	200	56-61	M20	110-125	5500

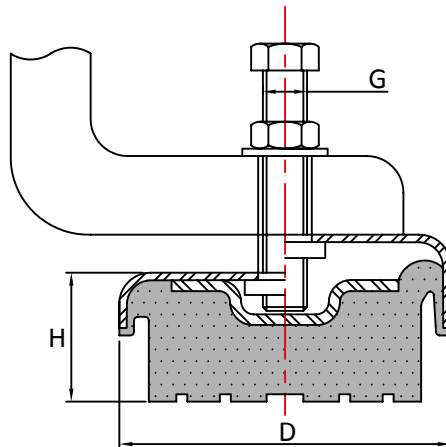

Part No	D	H	G	Max Load (kg)
KA01	80	32	M10/M12/M16	300
KA090	90	35	M12	400
KA05	120	35	M12/M16	800
KA02	150	40	M16	1000
KA16	160	40	M16/M20	1500
KA03	200	45	M20	3000

The KA Adjustable Levelling Feet are supplied without fixings

Max compression load in Kg deflection in mm.

This information is for guidance only. Customers are recommended to contact us for further technical information on products and applications. We reserve the right to alter specifications or withdraw products without notice.